



ZORANTECH
卓然照明

200W DC-DC Buck Waterproof LED Driver



■ Feature:

- Constant Current (C.C.) output, All-aluminum casing, IP67 waterproof
- Input voltage range: 36-48VDC (Support customization)
- High efficiency up to 95%, Output overshoot voltage change rate $\leq 10\%$
- Protections: Reverse Connection / Open Circuit / Over Voltage / Over Temp.
- dimming type: 0/1-10V or PWM or Resister(only NEK series)
- Flicker free, noise free design, 3-5 years warranty
- OEM & ODM, no MOQ, Support customization
- Comply with IEC international electrical quality standards

■ Application:

- LED outdoor lighting
- LED landscape lighting
- LED architectural lighting
- LED solar street light
- LED solar flood light
- LED solar garden light
- LED ship light
- LED car light

■ Description:

The DC-DC constant current waterproof driving power supply series produced by Zoran Technology is a dedicated driver for LED low-voltage lamps. Its operating voltage ranges from 36-48V DC or any custom voltage, and offers all custom boost or buck models with a rated output voltage range of 24V to 200V DC. Due to an efficiency of up to 95%, it features a fanless design and can operate in a natural air-cooling environment at temperatures ranging from -25°C to $+65^{\circ}\text{C}$. The entire series meets the IP67 protection level and is suitable for use in dry, humid, and rain-sprayed environments.

■ Electrical Specification

MODEL		ZR-LCM20NBK-200W	ZR-LCM30NBK-200W	ZR-LCM33NBK-200W	ZR-LCM20NEK-200W	ZR-LCM33NEK-200W
Output	Output Voltage <small>Note.1</small>	10-20 VDC	15-30 VDC	20-33 VDC	10-20 VDC	20-33 VDC
	Output Current <small>Note.2</small>	10000 mA	6670 mA	6060 mA	10000 mA	6060 mA
	Rated Power	200 W	200 W	200 W	200 W	200 W
	Current Tolerance <small>Note.4</small>	±2%	±2%	±2%	±2%	±2%
	Load Regulation	±3%	±3%	±3%	±3%	±3%
	Setup, Rise Time <small>Note.6</small>	≤ 50ms, ≤ 100ms/36V DC ≤ 50ms, ≤ 100ms/48V DC				
	Hold Up Time (Typ.)	≥8ms/36V DC ≥15ms/48V DC				
Input	Rated Voltage <small>Note.5</small>	36~48V DC (support customization)				
	DC Current (Typ.)	5.91A/36VDC	4.43A/48VDC	4.09A/52VDC		
	Limit voltage (Typ.)	33V-52V DC				
	Input signal (customizable)	Support 0/1-10V, PWM, Resister(only NEK series)				
	Full load Efficiency (Typ.)	≥92%	≥92%	≥92%	≥92%	≥92%
	Inrush Current (Typ.)	20A/36V DC, 30A/48V DC				
	Leakage Current (Typ.)	≤10mA				
Protection	Reverse Connection	Input reversed but no output. After removing the abnormal condition, it returns to normal				
	Over Voltage	Protection type: Shut down O/P voltage, re-power on to recover				
	Open Circuit	When no LED load is connected, the output voltage is automatically limited.				
	Over Temp.	The temperature drops, power is re-applied, and it automatically recovers				
Environment	Working Temperature	Tcase= -25 ~ +65 °C (Refer to "Derating curve")				
	Max Case Temperature	Tcase=+90 °C				
	Working Humidity	20-95%RH non-condensing				
	Storage TEMP. Humidity	-40~+85 °C 10-95%RH				
	Vibration	20-500Hz, 5.0G 10min/1 cycle, each X、Y、Z axes				
Safety & EMC	Safe Standards	UL8750,CSA C22.2 No.250.13-12;ENEC AS/NZS IEC EN61347-1;AS/NZS IEC EN61347-2-13 independent EN62348;GB19510.14 IP65 or IP67				
	Surge Voltage	Customizable surge protection is available. The regular products comply with the CE standards.				
	Withstand Voltage	I/P-O/P:500VDC I/P-FG:500VDC O/P-FG:500VDC				
	EMC Emission	Compliance to EN55015,EN61000-3-2 Class C(≥60% load);EN61000-3-3;GB17743;GB17625.1				
	EMC Immunity	Compliance to EN61000-4-2,3,4,5,6,8;EN61547 EN55024				
Others	Dimension (L*W*H)	186*68*39 mm				
	Weight	800g				
	Packing	15pcs/13kg/ctn				
Note	<p>1.All parameters not specially mentioned are measured at 48VDC input, rated load and 25 °C of ambient temperature.</p> <p>2.Length of seting time is measured at first cold starting. Turning ON/OFF the power supply may increase of the length of seting time.</p> <p>3.The power supply is considered as a component that will be operated in combination with final equipment. Since EMC performance will be affected by the complete installation, the final equipment manufactures must re-qualify EMC Directive on the complete installation again.</p> <p>4.When the maximum temperature point Tc of the shell of this series is lower than 60 °C , the working life is more than 30,000 hours.</p> <p>5.Please refer to the product warranty on Zoran Technology website http://www.zorantech.com.</p> <p>6.If you need other special parameters, please contact our customer service for consultation!</p>					

■ **Block Diagram**

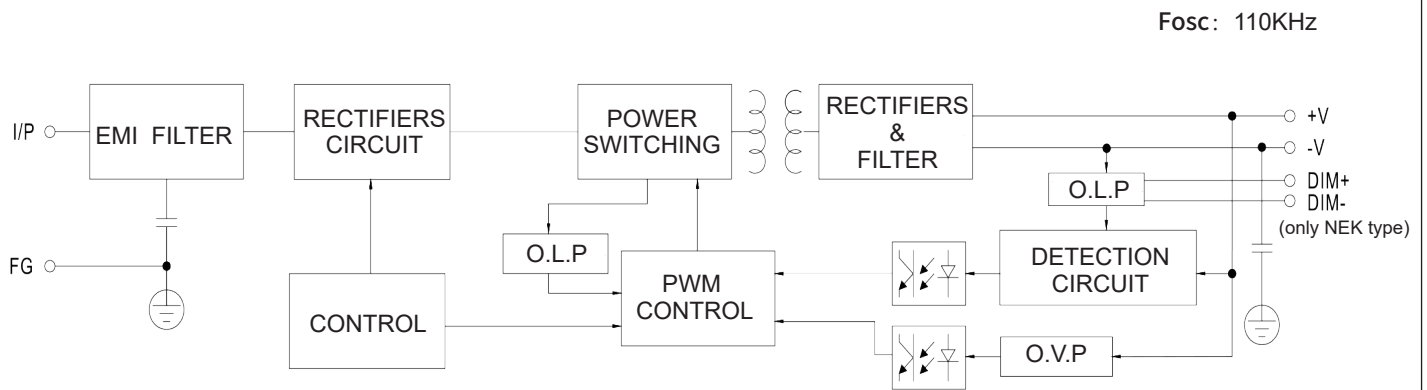

■ **Mechanical Specification**

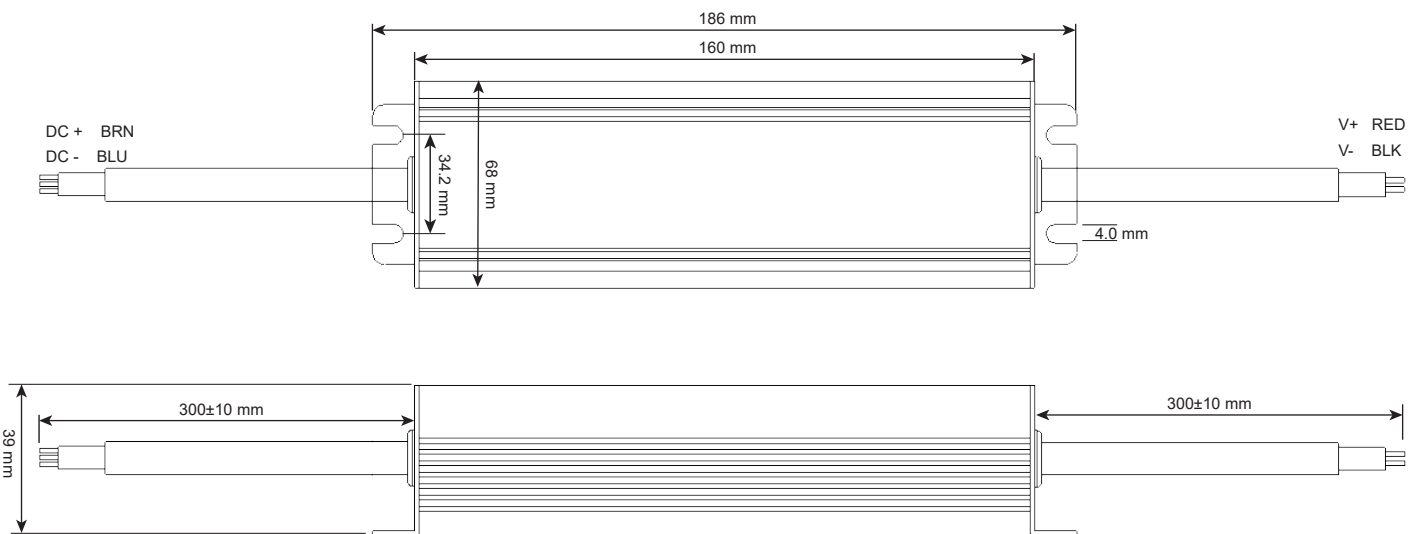

- ※ The brown line at the input end is the positive DC terminal (+), and the blue line is the negative DC terminal (-);
- ※ The red line at the output end outputs the positive voltage (V+), and the black line is the negative voltage (V-);
- ※ In addition, the length and cross-sectional area of the input and output lines can be customized according to customer requirements. For detailed information, please contact Zoran customer service.

■ **Life**

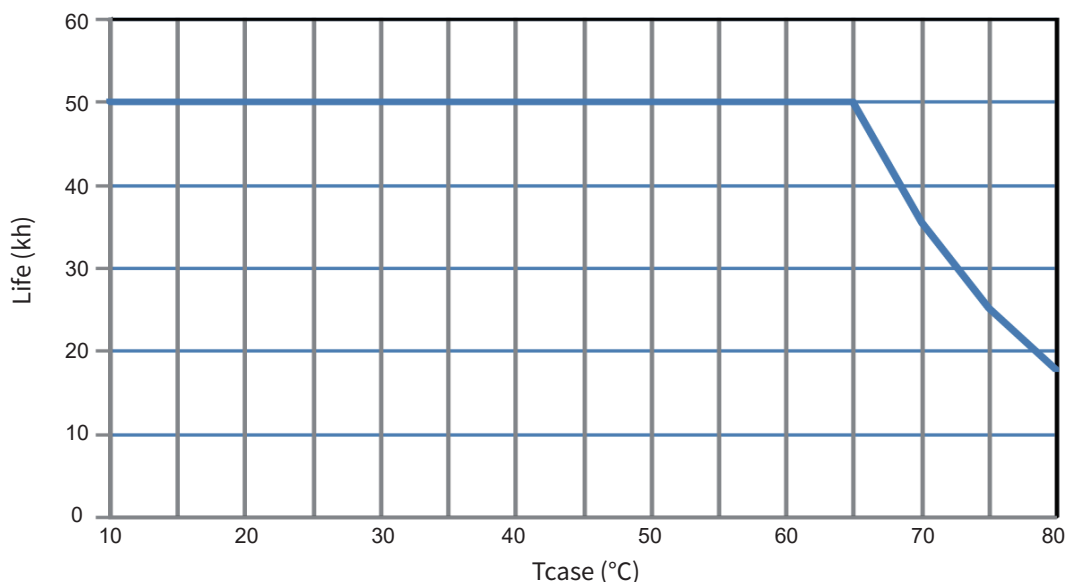

Output load VS Temperature

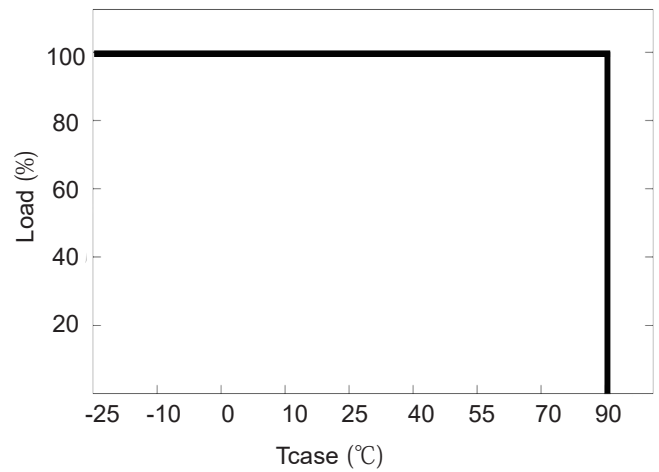
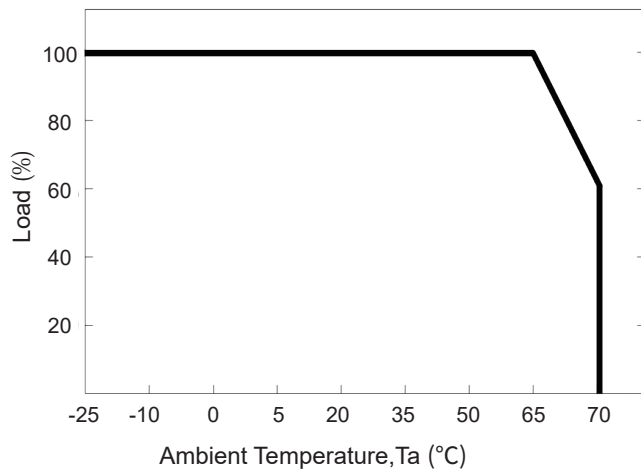

Static characteristic curve

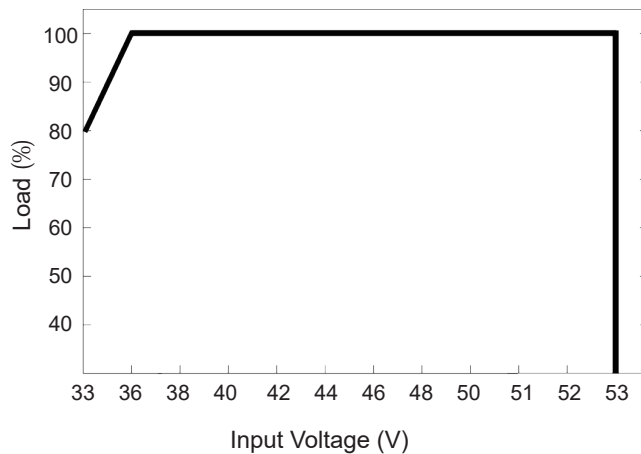

Efficiency VS Load

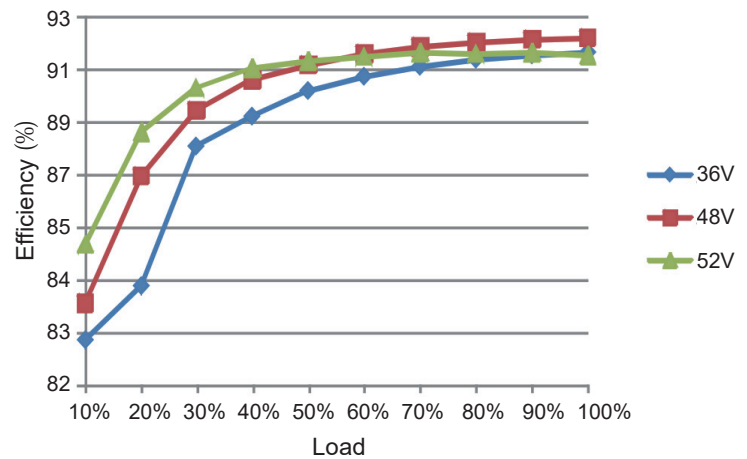

Precautions:

1. Shipping: Adapted to the transportation of cars, boats and planes, should be sheltered during transportation, sun protection, civilization loading and unloading;
2. Storage: Product has not when using should be put in the box, warehouse environment temperature -45 ~ +85 °C relative humidity 10% ~ 90%, warehouse in does not allow to have the harmful gas, inflammable, explosive products and corrosive chemical products and no strong mechanical vibration, impact and strong magnetic field effect. Packing should fill from the ground at least 20cm high, distance wall, heat source, window of air inlet at least 50cm, in this stated conditions of storage period generally is 2 years, more than two years should perform re-examination;
3. When installation should be conducive to heat dissipation, cannot install near heat source place;
4. Avoid long-term job in abnormal condition, such as overloading, short-circuit, non-work voltage range work;
5. Installation use, please pay attention to the working voltage of lamps and lanterns with the power output voltage of the agreement, of lamps and lanterns working current cannot exceed the power rating of the maximum output current;
6. Wiring connection should be strong and reliable, and add insulation protection against leakage;
7. The installation process must be carried out by a qualified electrician to avoid danger! Do not disassemble it. Under no circumstances should the LED power supply be covered by a thermal pad or similar material to ensure adequate heat dissipation;