



ZORANTECH
卓然照明

300W Triac & 0/1-10v 5 in 1 Dim. C.V waterproof led driver



■ Features

- Constant Voltage (C.V.) output, IP65 waterproof design
- Built-in active PFC function, High efficiency up to 92%
- Input voltage/Full range(up to 305VAC)
- Protections:Short circuit/Over voltage/Over load/Over temperature
- Transformer copper wire is F class, Temperature up to 155°C
- THD≤15%, Dimming range:0-100%/10-100%
- Built-in 5 in 1 dimming(Triac or 0-10V or 1-10V or PWM or Resistor)
- Noise free, flicker free, 5 years warranty
- OEM & ODM, no MOQ, Support customization

■ Applications

- LED outdoor lighting
- LED strip light
- LED kitchen light
- LED wall washer light
- LED underground light
- LED tunnel light
- LED garden lights
- LED line light
- LED stage lights
- LED Spot light

■ Description

The Triac & 0/1-10V 5 in 1 constant voltage waterproof series produced by Zoran Technology is an AC-to-DC dimming driver.operates from 90~305VAC and offers models with different rated voltage ranging ~between 12V/24V/36V/48V/54V etc. Thanks to the high efficiency up to 92%, with the fanless design, the entire series is able to operate for -40~+80°C case temperature under free air convection. It can be widely matched with all European and Austrian mainstream dimmers and lighting control systems, such as: Philips, Qisheng, crestron, Lutron and Leviton series etc. dimmers and systems, flicker free, achieve perfect soft dimming.

■ Electrical Specification

MODEL		ZR-HVF12NT-300W	ZR-HVF24NT-300W	ZR-HVF36NT-300W	ZR-HVF48NT-300W	ZR-HVF54NT-300W
Output	Output Voltage <small>Note.1</small>	12 VDC	24 VDC	36 VDC	48 VDC	60 VDC
	Output Current <small>Note.2</small>	25000 mA	12500 mA	8330 mA	6250 mA	5000 mA
	Rated Power	300 W	300 W	300 W	300 W	300 W
	Voltage Tolerance <small>Note.4</small>	±3%	±3%	±3%	±3%	±3%
	Auxiliary output(customizable)	12VDC	12VDC	12VDC	12VDC	12VDC
	Setup,Rise Time <small>Note.6</small>	500ms,100ms/115VAC 500ms,100ms/230VAC				
	Hold Up Time (Typ.)	10ms/115VAC 230VAC				
Input	Rate Voltage <small>Note.5</small>	90~265VAC or 100-277VAC				
	Frequency Range	48-62Hz				
	Power Factor	PF≥0.98/115VAC PF≥0.96/230VAC PF≥0.95/265VAC at full load				
	THD	THD≤15%(Bipolar)				
	Full load Efficiency	≥90%	≥90%	≥90%	≥91%	≥91%
	AC Current (Typ.)	2.86A/115VAC 1.43A/230VAC 1.24A/265VAC				
	Input signal (Typ.)	Triac / 0/1-10V / PWM / Resistor				
	No-load power consumption	≤1.0W				
Protection	Over Load	≤120% Recovers automatically after fault condition is removed				
	Short Circuit	Hiccup Mode,Recovers automatically after fault condition is removed				
	Over Voltage	Protection type:Shut down O/P voltage,re-power on to recover				
	Over Temperature	Shut down O/P voltage,re-power on to recover				
Environment	Working Temperature	-40~+80 C (Refer to "Derating curve")				
	Max Case Temperature	+90 C				
	Working Humidity	20-95%RH non-condensing				
	Storage TEMP. Humidity	-40~+80 C 10-95%RH				
	TEMP. Coefficient	±0.03%/C (0-50 C)				
Safety & EMC	Safe Standards	UL8750,CSA C22.2 No.250.13-12;ENEC AS/NZS IEC EN61347-1;AS/NZS IEC EN61347-2-13 independent EN62348;GB19510.14 IP65 or IP67				
	Withstand Voltage	I/P-O/P:3.75KVAC I/P-FG:2.0KVAC O/P-FG:1.0KVAC				
	Isolation Resistance	I/P-O/P,I/P-FG,O/P-FG:100M ohms/500VDC/25 C /70%RH				
	EMC Emission	Compliance to EN55015,EN61000-3-2 Class C(≥60% load);EN61000-3-3;GB17743;GB17625.1				
	EMC Immunity	Compliance to EN61000-4-2,3,4,5,6,8,11;EN61547 heavy industry level(surge 4KV)				
Others	Dimension (L*W*H)	254*108*42 mm				
	Weight	1200g				
	Packing	10pcs/12.5kg/ctn				
Note	<p>1.All parameters Not specially mentioned are measured at 230VAC input, rated load and 25 C of ambient temperature.</p> <p>2.Ripple&Noise are measured at 20MHz of bandwidth by using a 12"twisted pair-wire terminated with a 0.1uf & 47uf parallel capacitor.</p> <p>3.Tolerance: includes set up tolerance, line regulation and load regulation.</p> <p>4.The power supply is considered as a component that will be operated in combination with final equipment. Since EMC performance will be affected by the complete installation, the final equipment manufactures must re-qualify EMC Directive on the complete installation again.</p> <p>5.Please refer to the product warranty on Zoran Technology website http://www.zorantech.com.</p> <p>6.If you need other special parameters, please contact our customer service for consultation!</p>					

■ Block Diagram

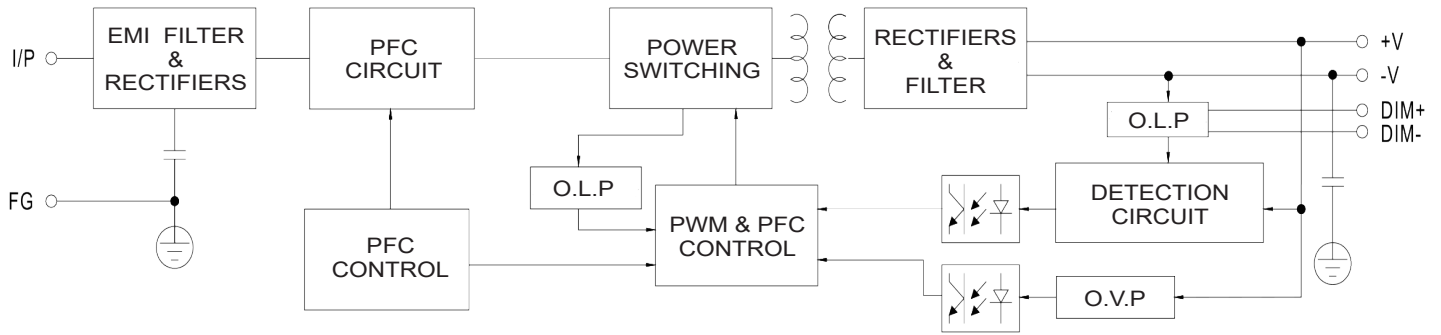

■ Mechanical Specification

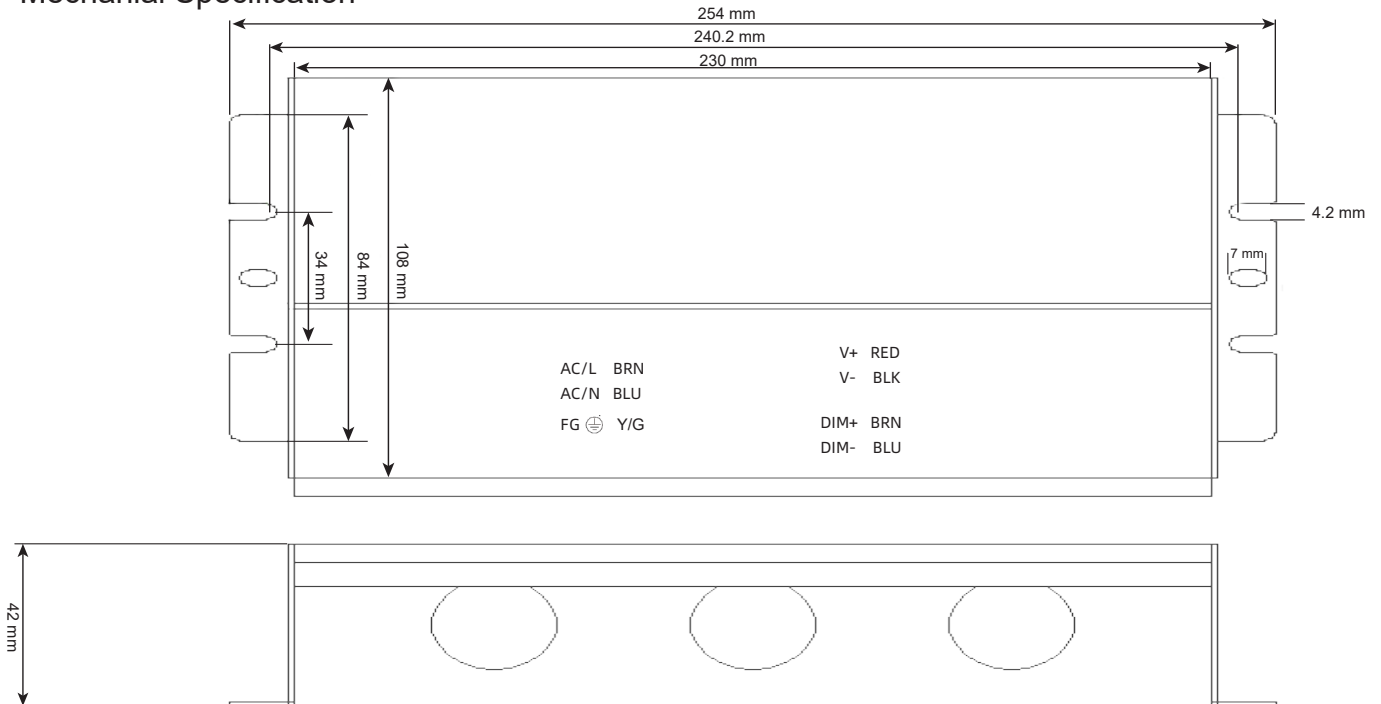

- ※ The yellow-green wire at the input is the ground (FG), the brown wire is the AC phase wire(L),and blue wire is the AC neutral wire (N);
- ※ The brown wire at the output is the positive dimming signal (10v+) and the blue wire is the dimming signal negative (10v-), the red wire is the positive output voltage(V+)and black wire is the negative output voltage(V-);
- ※ In addition, the length and thickness of the input and output lines can be customized according to customer requirements. Please contact Zoran Customer Service for details;

■ Life

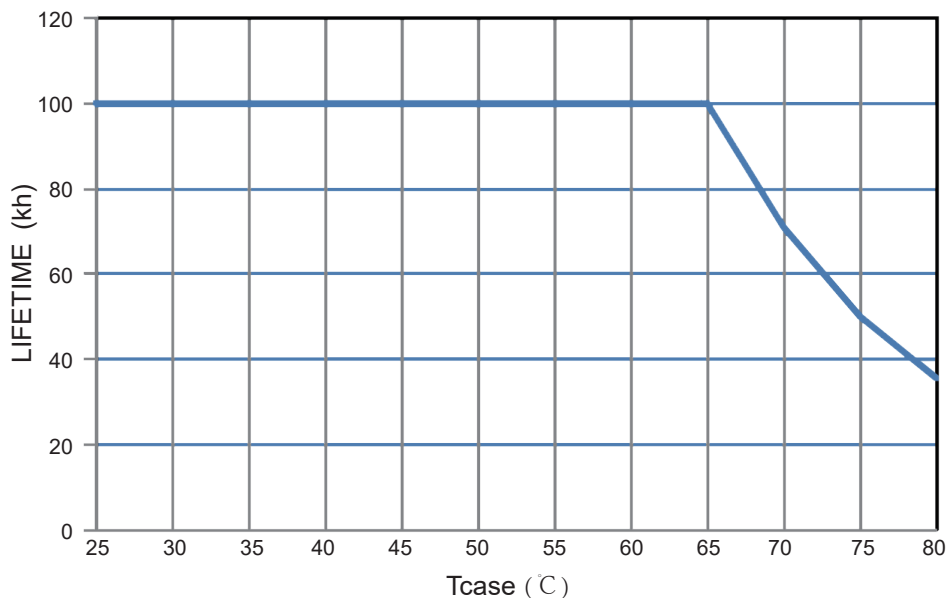

Dimming Operation

※ Triac Dimming Operation

The following diagram depicts a typical installation utilizing the Triac series :

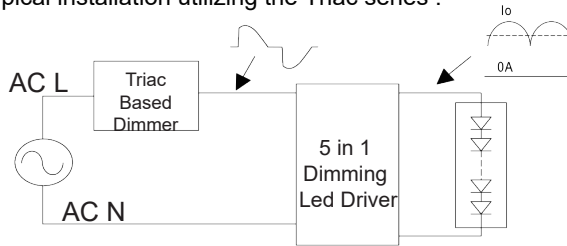

※ 4 in 1 dimming function

- Output constant current level can be adjusted by applying one of the three methodologies between DIM+ and DIM-: 0-10VDC, or 1-10VDC, or 10V PWM Signal or resistance.
- Direct connecting to LED is suggested. It is not suitable to be used with additional drivers.
- Dimming source current from power supply: 100μA(typ.)

◎ Applying additive 0~10VDC:

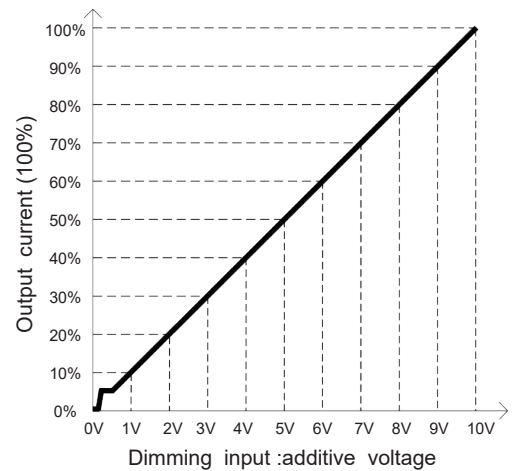
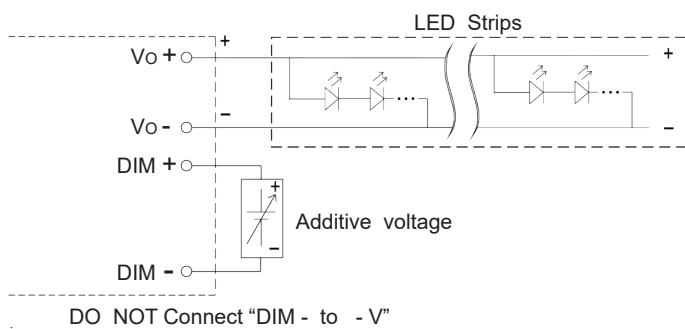

◎ Applying additive 10V PWM signal(frequency range 100Hz~3KHz):

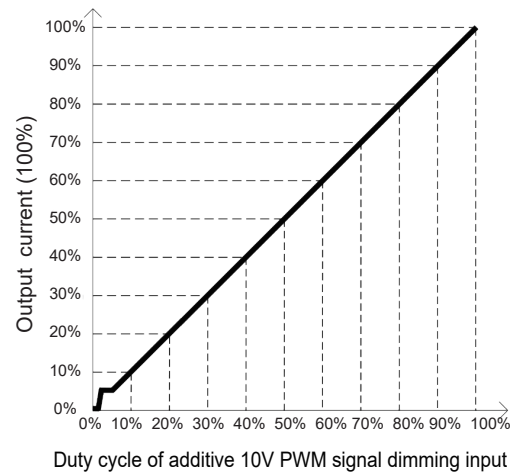
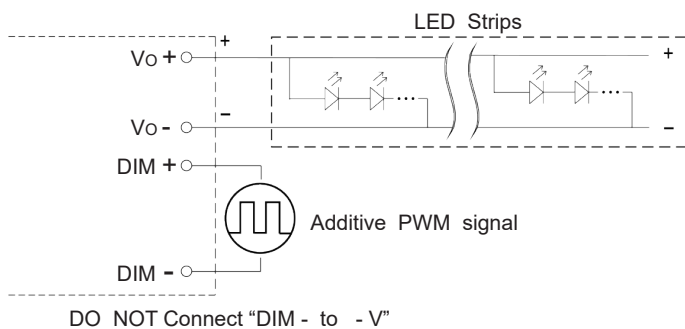

◎ Applying additive resistance:

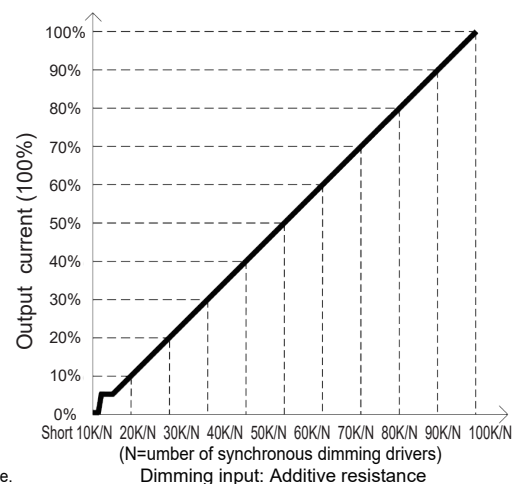
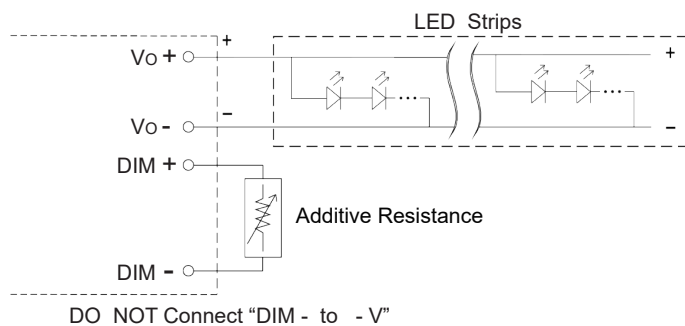

Note:

1. Min. dimming level is about 3% and the output current is not defined when $0% < I_{out} < 3%$.
2. The output current could drop down to 0% when dimming input is about 0kΩ or 0Vdc, or 10V PWM signal with 0% duty cycle.

■ Output load VS Temperature

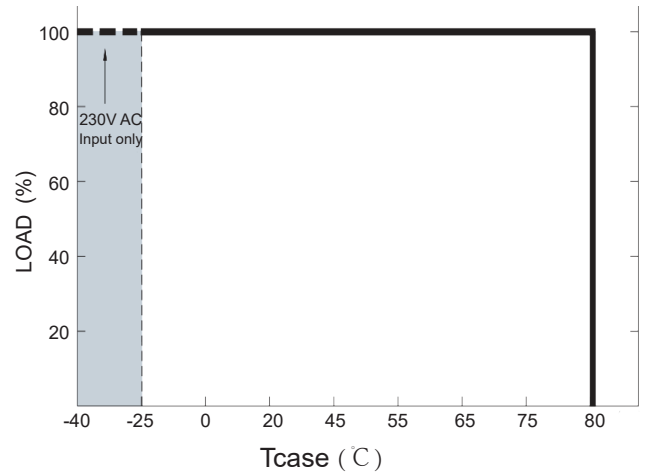
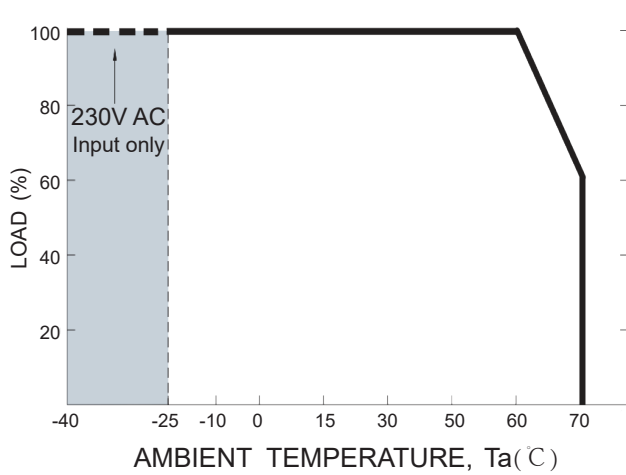

■ Static characteristic curve

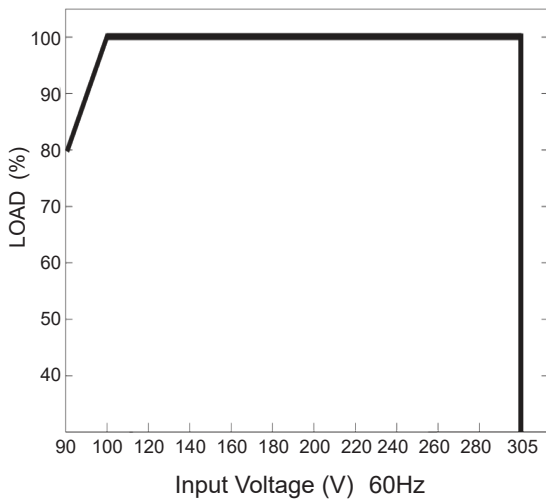

■ PF characteristic curve

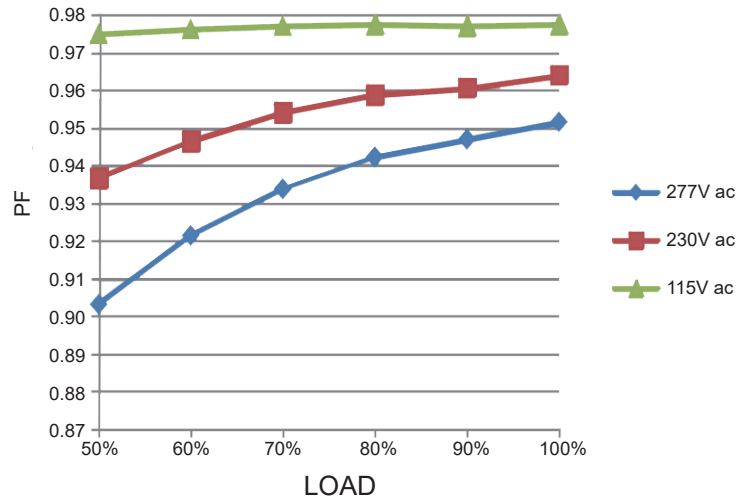

※ De-rating is needed under low input voltage.

■ THD characteristic curve

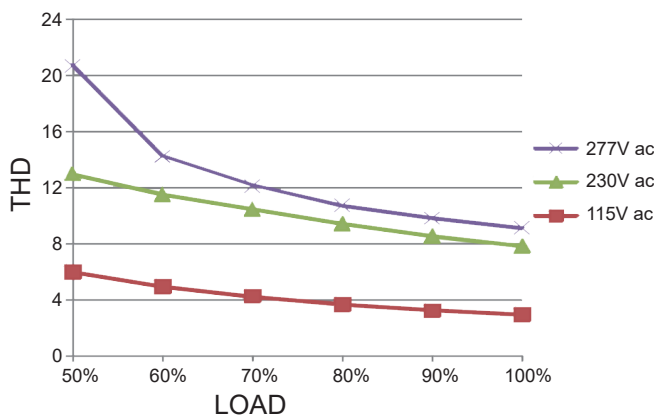

■ Efficiency VS Load

